

VISIT US ONLINE AT:

ninjakitchen.com.au

ninjakitchen.co.nz

Or follow us on any of our social media pages:

  @ninjakitchenapac

NOTE: Save these instructions. Keep for future reference.



AG551ANZ

INSTRUCTIONS

NINJA® Foodi® SMART XL GRILL



Proudly distributed by:
Mann&Noble Pty Ltd
Building D
33 Quarry Road
Erskine Park NSW, Australia, 2759
AUS 02 8801 7666
NZ 0800 112 660

Illustrations may differ from actual product. We are constantly striving to improve our products, therefore the specifications contained herein are subject to change without notice.

FOODI and NINJA are registered trademarks of SharkNinja Operating LLC.

© 2021 SharkNinja Operating LLC

PRINTED IN CHINA



AG551ANZSeries_IB_MP_Mv16

 ninjakitchen.com.au

 ninjakitchen.co.nz

THANK YOU

for purchasing the Ninja® Foodi® Smart XL Grill

REGISTER YOUR PURCHASE

 ninjakitchen.com.au

 ninjakitchen.co.nz

RECORD THIS INFORMATION

Model Number: _____

Serial Number: _____

Date of Purchase: _____
(Keep receipt)

Store of Purchase: _____

TECHNICAL SPECIFICATIONS

Voltage: 220-240V~ 50-60HZ

Watts: 1760W

CONTENTS

Product Registration	2
Important Safeguards	4
Parts	6
Getting to Know Your Grill	7
Function Buttons	7
Operating Buttons	7
Before First Use	7
Using Your Grill	8
Splatter Guard	8
GrillControl Technology	8
Batch Grilling	8
Using the Smart Cooking Probe	9
Using the Probe in Different Cooking Scenarios	10
How to Correctly Insert the Probe	10
Cooking Functions	12
Grill	12
Air Fry	13
Roast	14
Bake	15
Dehydrate	16
Reheat	17
Troubleshooting	18
Cleaning	19
Warranty	20

IMPORTANT SAFEGUARDS

HOUSEHOLD USE ONLY • READ ALL INSTRUCTIONS BEFORE USE

Read all instructions before using your Ninja® Foodi® Smart XL Grill

When using electrical appliances, basic safety precautions should always be followed, including the following:

⚠ WARNING

- 1 To eliminate a choking hazard for young children, discard all packaging materials immediately upon unpacking.
- 2 This appliance can be used by persons with reduced physical, sensory or mental capabilities or lack of experience and knowledge if they have been given supervision or instruction concerning use of the appliance in a safe way and understand the hazards involved.
- 3 Keep the appliance and its cord out of reach of children. **DO NOT** allow the appliance to be used by children. Close supervision is necessary when used near children.
- 4 This appliance is for household use only. **DO NOT** use this appliance for anything other than its intended use. **DO NOT** use in moving vehicles or boats. **DO NOT** use outdoors. Misuse may cause injury.
- 5 Ensure the surface is level, clean and dry. **DO NOT** place the appliance near the edge of a worktop during operation.
- 6 **ALWAYS** ensure the appliance is properly assembled before use.
- 7 When using this appliance, provide at least 15.25 cm (6 inches) of space above and on all sides for air circulation.
- 8 **DO NOT** use an extension cord. A short power-supply cord is used to reduce the risk of children grabbing the cord or becoming entangled and to reduce the risk of people tripping over a longer cord.
- 9 To protect against electrical shock **DO NOT** immerse cord, plugs, or main unit housing in water or other liquid.
- 10 **DO NOT** use the appliance if there is damage to the power cord or plug. Regularly inspect the appliance and power cord. If the appliance malfunctions or has been damaged in any way, immediately stop use and call Customer Service.
- 11 **NEVER** use socket below worktop surface.
- 12 **NEVER** connect this appliance to an external timer switch or separate remote-control system.
- 13 **DO NOT** place appliance and let cord hang over edges of tables, counters or touch hot surfaces including on or near a hot gas or electric burner, or in a heated oven.
- 14 Only use recommended accessories included with this appliance or authorized by SharkNinja. The use of accessories or attachments not recommended by SharkNinja may cause a risk of fire or injury.
- 15 Before placing any accessory into the cooker, ensure they are clean and dry.
- 16 **DO NOT** use the appliance without the removable cooking pot and splatter guard installed.
- 17 **ALWAYS** ensure lid is fully closed before operating.
- 18 **DO NOT** move the appliance when in use.
- 19 **DO NOT** cover the air intake vent or air socket vent while unit is operating. Doing so will prevent even cooking and may damage the unit or cause it to overheat.

- 20 **DO NOT** touch hot surfaces. Appliance surfaces are hot during and after operation. To prevent burns or personal injury, **ALWAYS** use protective hot pads or insulated oven gloves and use available handles and knobs.
- 21 **DO NOT** touch accessories during or immediately after cooking. The grill plate and basket becomes extremely hot during the cooking process. Avoid physical contact while removing the accessory from the appliance. To prevent burns or personal injury **ALWAYS** use care when interfacing with product. Recommend use of long handed utensil and protective **hot pads or insulated oven gloves**.
- 22 **DO NOT** use this appliance for deep-frying.
- 23 **DO NOT** place hands near the Smart Cooking probe cord when in use to prevent burning or scalding.
- 24 The Smart Cooking probe does **NOT** replace an external food thermometer.
- 25 To prevent possible illness, **ALWAYS** use a probe to check that your food is cooked to the recommended temperatures.
- 26 Should a grease fire occur or the unit emits black smoke, unplug immediately. Wait for smoking to stop before removing any cooking accessories.
- 27 Please refer to the Cleaning & Maintenance section for regular maintenance of the appliance.
- 28 To disconnect, turn any control to "off", then unplug from socket when not in use and before cleaning.
- 29 Allow to cool before cleaning, disassembly, putting in or taking off parts and for storage.
- 30 **DO NOT** clean with metal scouring pads. Pieces can break off the pad and touch electrical parts, creating a risk of electric shock.
- 31 Cleaning and user maintenance shall not be made by children.



Indicates to read and review instructions to understand operation and use of product.



Indicates the presence of a hazard that can cause personal injury, death or substantial property damage if the warning included with this symbol is ignored.



Take care to avoid contact with hot surface. Always use hand protection to avoid burns.



For indoor and household use only.

SAVE THESE INSTRUCTIONS

PARTS

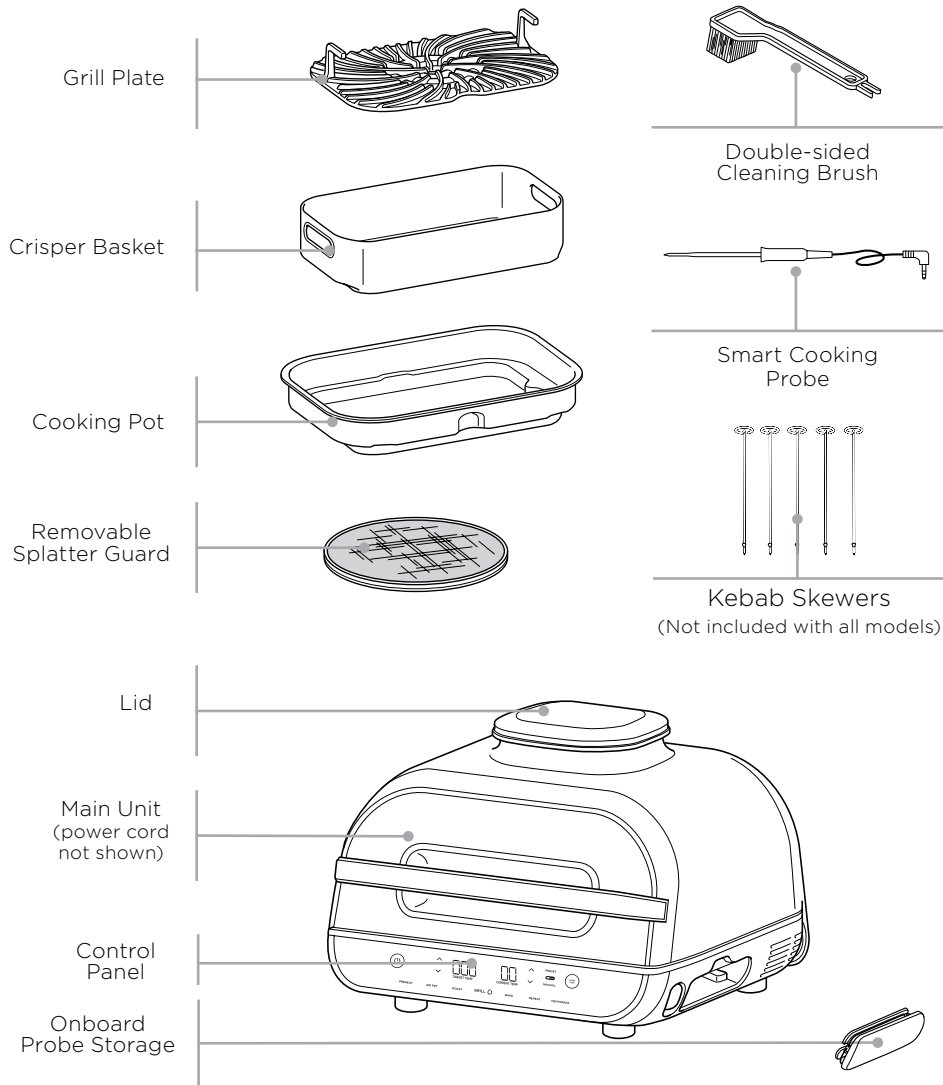

To order additional parts and accessories, visit ninjakitchen.com.au or ninjakitchen.co.nz or contact Customer Service at 02 8801 7666 or 0800 862 0453.

GETTING TO KNOW YOUR GRILL



The control panel display shows time in an HH:MM format.
The display to the right reads 20 minutes.

FUNCTION BUTTONS

GRILL Grill indoors while creating even char, grill marks and grilled flavour.

AIR FRY For crispiness and crunch with little to no oil.

BAKE Cakes, treats, desserts and more.

ROAST Meats, roast vegetables, and more.

DEHYDRATE Dehydrate meats, fruits, and vegetables for healthy snacks.

REHEAT Revive leftovers by gently warming them, leaving you with crispy results.

OPERATING BUTTONS

POWER button Once the unit is plugged in, press the power button to turn on the unit. Pressing it during cooking stops the current cooking function and turns off the unit.

Left arrows Use the up and down arrows to the left of the display to adjust the cooking temperature in any function or to set the internal outcome when using PRESET and MANUAL buttons.

MANUAL button Switches the display screen so you can manually set the probe internal outcome. Manual button does not work with Dehydrate function.

PRESET button Switches the display screen so you can set the probe, food type, and internal outcome based on the preset temperatures. Preset button does not work with Dehydrate function.

Right arrows Use the up and down arrows to the right of the display to set the food type when using PRESET or to adjust the cook time when not cooking with the Foodi Probe.

NOTE: To adjust the temperature or time during cooking, press the up and down arrows. The unit will then resume at those settings.

START/STOP button After selecting temperature and time, press the START/STOP button to begin cooking.

Standby Mode If there has been no interaction with the control panel for 10 minutes and the unit is not cooking, the unit will go into Standby Mode and the control panel will dim.

Preheat If the unit is preheating, it will be indicated by a progress bar on the display screen and the PREHEAT button will illuminate. To turn off preheat, press the PREHEAT button. "ADD FOOD" will then be displayed on the unit.

BEFORE FIRST USE

- 1 Remove all packaging material, promotional labels, and tape from the unit.
- 2 Remove all accessories from the package and read this manual carefully. Please pay particular attention to operational instructions, warnings, and important safeguards to avoid any injury or property damage.
- 3 Wash the grill plate, splatter guard, crisper basket, probe, cleaning brush, and cooking pot in warm, soapy water, then rinse and dry thoroughly. All accessories, except the probe, are dishwasher safe. **NEVER** clean the main unit or probe in the dishwasher.

USING YOUR GRILL

SPLATTER GUARD

Located on the underside of the lid, the splatter guard keeps the heating element clean. **ALWAYS** ensure the splatter guard is installed when cooking. Failure to use the splatter guard will result in oil buildup on the heating element, which can cause smoking.

Removing the splatter guard

Remove the splatter guard for cleaning after every use. Once the splatter guard has cooled completely, remove it by pushing the upper right knob towards the back of the lid. This will release the splatter guard, allowing you to pull it out of the slot along the back of the lid.

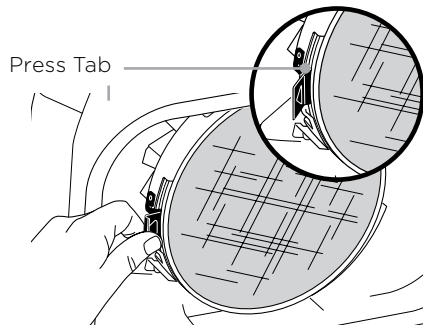

Installing the splatter guard

To install, slide the guard under the fixed tab to the left hand side. Insert the smoke screen so the grooves on the smoke screen match that of the fixed heat guard ring. Then gently push the splatter guard upward until it clicks into the clip on the front of the lid.

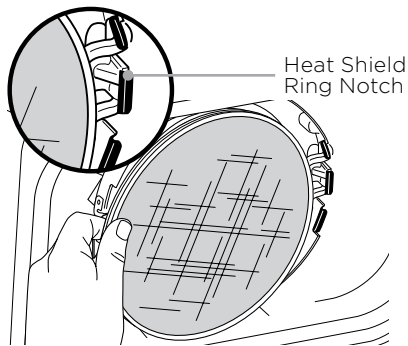

GRILLCONTROL TECHNOLOGY

When using the Grill function, you will need to select the grill plate temperature setting. Below are recommended temperature levels for common ingredients.

LOW (200°C)	MED (230°C)	HI (250°C)	MAX (260°C)
<ul style="list-style-type: none"> Bacon Sausages When using thick BBQ sauce 	<ul style="list-style-type: none"> Frozen meats Marinated/ sauced meats 	<ul style="list-style-type: none"> Steaks Chicken Burgers Hot dogs Meat kebabs 	<ul style="list-style-type: none"> Veggies Fruit Pizzas Fresh/ frozen seafood Veggie Kebabs

NOTE: For less smoke, we recommend using vegetable, coconut, avocado, grapeseed, or vegetable oil instead of olive oil. Heating oil past its smoke point can impart food with a burnt, acrid flavour.

NOTE: The unit may produce smoke when cooking ingredients on a hotter setting than what is recommended. For more cooking charts, refer to your Inspiration Guide or visit ninjakitchen.com/au or ninjakitchen.co/nz.

Switching to Grill after using another function

If the unit is already warm from using a different function, "ADD FOOD" may appear on the screen immediately. We recommend allowing the grill plate to heat up for at least 6 minutes before placing ingredients on it.

Batch grilling

When grilling more than two consecutive batches of food, it is recommended that you empty the fat/oil from the removable cooking pot. It is also HIGHLY recommended to clean the splatter shield in between uses. This will help prevent grease from burning and causing smoke.

If you would like to skip the Preheat process, press the PREHEAT button.

USING THE SMART COOKING PROBE

IMPORTANT: DO NOT place hands near Smart Cooking Probe cord when in use to prevent burning or scalding.

Before First Use

Make sure the probe jack is free of any residue and the cord is free of knots before plugging it into the socket.

- 1 Pull the probe storage compartment on the right side of the unit outward. Then unwind the wire from the compartment to remove the probe.
- 2 Plug the probe into the input jack under the orange silicone cover. Push firmly on the plug until it cannot go into the jack any further. Place the storage compartment back onto the side of the unit.

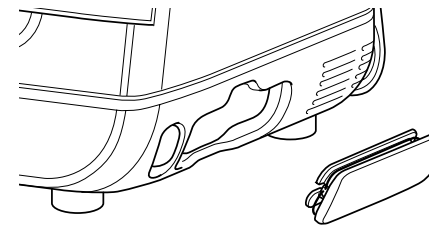

NOTE: There is no need to set a cook time, as the unit will automatically turn off the heating element and alert you when your food has completed cooking.

- 3 Once the probe is plugged into the jack, it will enable and illuminate the PRESET and MANUAL probe buttons. Select the desired cook function and cook temperature.

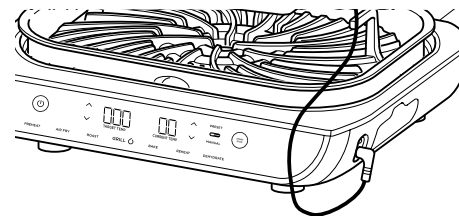

- 4 Press PRESET and use the arrows to the right of the display to select your desired food type and the arrows to the left of the display to set the internal outcome of your food (Rare through Well).

NOTE: Cooking different meats or to different preferences? Refer to page 10 for details on programming.

If selecting MANUAL button, use the below recommended internal cook temps.

FOOD TYPE:	SET LEVEL TO:
Fish	Medium Rare (50°C)
	Medium (55°C)
	Medium Well (60°C)
	Well Done (65°C)
Chicken/Turkey	Well Done (75°C)
Pork	Medium Rare (50°C)
	Medium (55°C)
	Medium Well (65°C)
	Well Done (70°C)
Beef/Lamb	Rare (50°C)
	Medium Rare (55°C)
	Medium (60°C)
	Medium Well (65°C)
	Well Done (70°C)

- 5 Place the accessory required for your selected cook function in the unit and close the lid. Press START/STOP to begin preheating.

NOTE: Refer to the local food standards for recommended food safe temperatures.

NOTE: Preset cooking levels for BEEF/LAMB are lower than normal recommendations as unit will carry-over cook 5-10°C.

USING YOUR GRILL - CONT.

- 6 While the unit is preheating, insert the probe horizontally into the centre of the thickest part of the piece of protein.

Refer to the chart on the adjacent page on further probe placement instructions.

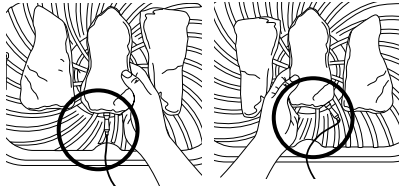

Correct probe placement.
Probe grip is fully inside unit.

- 7 When the unit has preheated and "ADD FOOD" appears on the screen, open the lid, place food with inserted probe in the unit, and close the lid over the probe cord.
- 8 The progress bar at the top of the display will track the stages of cook. Flashing indications progression to that stage.

RARE > MED RARE < MED MED WELL WELL

NOTE: When using Roast and Grill, the unit will beep and display FLIP. Flipping is optional but recommended

- 9 The unit will automatically stop when your selection is almost reached, as it accounts for carry-over cooking and GET FOOD will display on the screen.

^ GET FOOD ^
v v

- 10 Transfer the protein to a plate while REST displays on the screen. The protein will continue to cook which will take about 3-5 minutes. This is an important step, as not resting could lead to results looking "less cooked". Carry-over cook times can vary based on size of protein, cut of protein and type of protein.

NOTE: To check the internal temperature of other pieces of protein, press and hold MANUAL and insert the probe into each piece of meat.

USING THE PROBE IN DIFFERENT COOKING SCENARIOS:

Cooking 2 or more proteins of the same size to different levels of outcome:

Insert probe in the protein with the higher desired level of outcome. Use the Preset feature to choose the level of outcome, then monitor the progress bar—when the desired lower level of outcome is reached in that protein, remove the protein without the probe from the unit. Continue cooking the remaining protein until the desired level of outcome is reached.

Cooking 2 or more proteins of different sizes:

Insert probe in the smaller protein and use the Preset feature to choose the level of outcome. When that protein is done cooking, remove it from the unit. Then transfer probe to the larger protein and use the Preset feature to choose its level of outcome.

Cooking 2 or more different types of protein:

Insert probe in the protein with the lower desired level of outcome. Use the Manual feature to choose the desired internal temperature. When that protein is done cooking, remove it from the unit. Then transfer probe to the other protein and use the Manual feature to choose the desired internal temperature.

NOTE: The probe will be HOT. Use either oven gloves or tongs to take the probe out of the food.

HOW TO INSERT THE PROBE

FOOD TYPE:	PLACEMENT	CORRECT	INCORRECT
Steaks Pork chops Lamb chops Chicken breasts Burgers Tenderloins Fish fillets	<ul style="list-style-type: none"> Insert probe horizontally into the centre of the thickest part of the meat. Make sure the tip of the probe is inserted straight into the centre of the meat, not angled toward the bottom or top of it. Make sure the probe is close to (but not touching) the bone and away from any fat or gristle. <p>NOTE: The thickest part of the fillet may not be the centre. It is important that the end of the probe hits the thickest part so desired results are achieved.</p>		
Whole chicken	<ul style="list-style-type: none"> Insert probe horizontally into the thickest part of the breast, parallel to, but not touching, the bone. Make sure the top reaches the centre of the thickest part of the breast and doesn't go all the way through the breast into the cavity. 		

NOTE: DO NOT use the probe with frozen foods or for cuts of meat thinner than 1.5cm.

USING YOUR GRILL - CONT.

COOKING FUNCTIONS

Plug in the unit and press the power  button to turn it on.

Grill

- 1 Place the cooking pot in the unit with the indent on the pot aligned with the rear bump on the main unit. Then place the grill plate in the pot with the handles facing up. Ensure the splatter guard is in place, then close the lid.

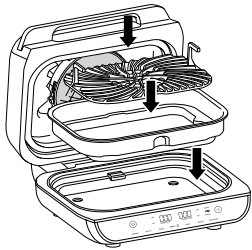

NOTE: If you are using the probe, refer to pages 9-11 for instructions.

- 2 Press the GRILL button. The default temperature setting will display. Use the set of arrows to the left of the display to adjust the temperature.



- 3 Use the set of arrows to the right of the display to adjust the cook time, in 1-minute increments, up to 30 minutes, or, if using the probe, refer to the instructions on pages 9-11.



- 4 Press START/STOP to begin preheating. The progress bar will begin illuminating. It will take approximately 10 minutes for the unit to preheat.

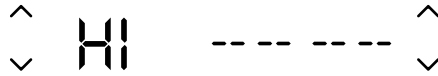

- 5 When preheating is complete, the unit will beep and "ADD FOOD" will appear on the display.



- 6 Open the lid and place ingredients on the grill plate. Once the lid is closed, cooking will begin and the timer will start counting down.

NOTE: If you would like to use the probe to check your food's internal temperature, press MANUAL for 2 seconds and the food's internal temperature will appear on the screen for 5 seconds.

- 7 When cook time is complete, the unit will beep and END will appear on the display.



NOTE: If batch cooking, refer to page 8 for instructions.

Air Fry

- 1 Place cooking pot in the unit with the indent on the pot aligned with the bump on the main unit. Place the crisper basket in the pot. Ensure the splatter guard is in place, then close the lid.

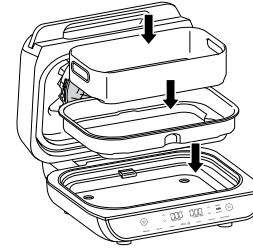

- 2 Press the AIR FRY button. The default temperature setting will display. Use the set of arrows to the left of the display to adjust the temperature.



- 3 Use the set of arrows to the right of the display to adjust the cook time, in 1-minute increments, up to 1 hour, or, if using the probe, refer to the instructions on pages 9-11.



- 4 Press START/STOP to begin preheating. The progress bar will begin illuminating. It will take approximately 3 minutes for the unit to preheat.



NOTE: While preheating is strongly recommended for best results, you can skip it by pressing the PREHEAT button. "ADD FOOD" will appear on the display. Open the lid and place ingredients in the crisper basket. Once the lid is closed, cooking will begin and the timer will start counting down.

- 5 When preheating is complete, the unit will beep and "ADD FOOD" will appear on the display.



- 6 Open the lid and place ingredients in the crisper basket. Once the lid is closed, cooking will begin and the timer will start counting down.

NOTE: If you would like to use the probe to check your food's internal temperature, press MANUAL for 2 seconds and the food's internal temp will appear on the screen for 5 seconds.

- 7 For best results, we recommend shaking ingredients frequently. When you open the lid, the unit will pause. Use silicone-tipped tongs or oven mitts to shake the basket. When done, replace the basket and close the lid. Cooking will automatically resume after lid is closed.

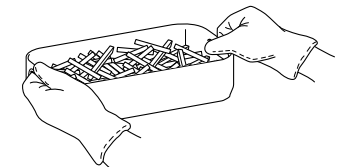

- 8 When cook time is complete, the unit will beep and END will appear on the display.



USING YOUR GRILL - CONT.

Roast

- 1 Place cooking pot in the unit with the indent on the pot aligned with the bump on the main unit. Ensure the splatter guard is in place, then close the lid.

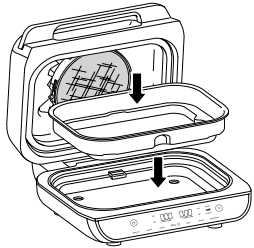

- 2 Press the ROAST button. The default temperature setting will display. Use the set of arrows to the left of the display to adjust the temperature.



NOTE: Convert traditional oven recipes by reducing the temperature by 10°C. Check food frequently to avoid overcooking.

- 3 Use the set of arrows to the right of the display to adjust the cook time, in 1-minute increments up to 1 hour and 5-minute increments from 1 to 4 hours, or, if using the probe, refer to the instructions on pages 9-11.



- 4 Press START/STOP to begin preheating. PRE will illuminate on the right side of the display and the progress bar will begin illuminating. It will take approximately 3 minutes for the unit to preheat.



NOTE: While preheating is strongly recommended for best results, you can skip it by pressing the PREHEAT button. "ADD FOOD" will appear on the display. Open the lid and place ingredients in the cooking pot. Once the lid is closed, cooking will begin and the timer will start counting down.

- 5 When preheating is complete, the unit will beep and "ADD FOOD" will appear on the display.



- 6 Open the lid and place ingredients in the pot. Once the lid is closed, cooking will begin and the timer will start counting down.

NOTE: If you would like to use the probe to check your food's internal temperature, press MANUAL for 2 seconds and the food's internal temperature will appear on the screen for 5 seconds.

- 7 When cook time is complete, the unit will beep and END will appear on the display.



Bake

- 1 Place cooking pot in the unit with the indent on the pot aligned with the bump on the main unit. Ensure the splatter guard is in place, then close the lid.

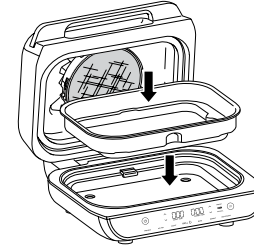

- 2 Press the BAKE button. The default temperature setting will display. Use the set of arrows to the left of the display to adjust the temperature.



NOTE: Convert traditional oven recipes by reducing the temperature by 10°C. Check food frequently to avoid overcooking.

- 3 Use the set of arrows to the right of the display to adjust the cook time, in 1-minute increments, up to 1 hour and in 5-minute increments from 1 to 2 hours, or, if using the probe, refer to the instructions on pages 9-11.



- 4 Press START/STOP to begin preheating. PRE will illuminate on the right side of the display and the progress bar will begin illuminating. It will take approximately 3 minutes for the unit to preheat.

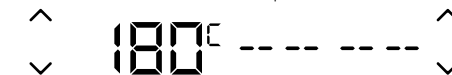

NOTE: While preheating is strongly recommended for best results, you can skip it by pressing the PREHEAT button. "ADD FOOD" will appear on the display. Open the lid and place ingredients in the crisper basket. Once the lid is closed, cooking will begin and the timer will start counting down.

- 5 When preheating is complete, the unit will beep and "ADD FOOD" will appear on the display.



- 6 Open the lid and add ingredients to the pot or set the bake pan directly in the pot, and close the lid to start cooking. Once the lid is closed, cooking will begin and the timer will start counting down.

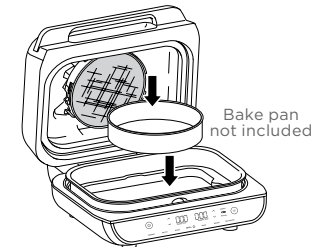

NOTE: If you would like to use the probe to just check your food's internal outcome, press MANUAL for 2 seconds and the food's internal temperature will appear on the screen for 5 seconds.

- 7 When cook time is complete, the unit will beep and END will appear on the display.



USING YOUR GRILL - CONT.

Dehydrate

- 1 Place cooking pot in the unit with the indent on the pot aligned with the bump on the main unit. Place a single layer of ingredients in the pot. Then place the crisper basket in the pot on top of the ingredients and add another layer of ingredients to the basket. Ensure the splatter guard is in place, then close the lid.

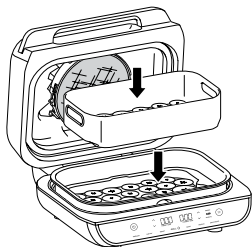

- 2 Press the DEHYDRATE button. The default temperature setting will display. Use the set of arrows to the left of the display to adjust the temperature.



- 3 Use the set of arrows to the right of the display to adjust the dehydration time, in 15-minute increments, up to 12 hours.

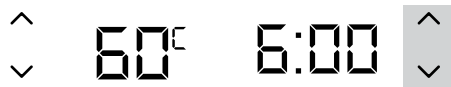

- 4 Press START/STOP to begin. (The unit does not preheat in Dehydrate mode.)
- 5 When dehydration time is complete, the unit will beep and END will appear on the display.



Reheat

- 1 Place cooking pot in the unit with the indent on the pot aligned with the bump on the main unit. Place the crisper basket in the pot, then close the lid.

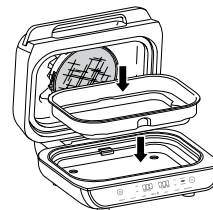

- 2 Press the REHEAT button. The default temperature setting will display. Use the set of arrows to the left of the display to adjust the temperature.



- 3 Use the up and down right arrows to set the cook time, in 1-minute increments, up to 1 hour, or follow the instructions on the previous pages to set a temperature using preset or manual.



- 4 Press START/STOP to begin preheating. PRE will illuminate on the right side of the display and the progress bar will begin showing. It can take up to 3 minutes to preheat.

- 5 When preheating is complete, the unit will beep and "ADD FOOD" will appear on the display screen.

- 6 Open the lid and place ingredients in the crisper basket. Once the lid is closed, cooking will begin and the timer will start counting down.

NOTE: If you would like to use the probe to check your food's internal temperature, press MANUAL for 2 seconds and the food's internal temp will appear on the screen for 5 seconds.

- 7 For best results, we recommend shaking ingredients frequently. When you open the lid, the unit will pause. Use silicone-tipped tongs or oven mitts to shake the basket. When done, replace the basket and close the lid. Cooking will automatically resume after lid is closed.

- 8 When cook time is complete, the unit will beep and END will appear on the display.



TROUBLESHOOTING

- **“ADD FOOD” appears on the control panel display.**
The unit has completed preheating and it is now time to add your ingredients.
- **“Shut Lid” appears on the control panel display.**
The lid is open and needs to be closed for the selected function to start.
- **“Plug In” appears on the control panel display.**
The probe is not plugged into the socket on the right side of the control panel. Plug the probe in before proceeding. Press the probe in until you hear a click.
- **“PRBE ERR” appears on the control panel display.**
This means the unit timed out before food reached the set internal temperature. As a protection for the unit, it can run for only certain lengths of time at specific temperatures.
- **“E” appears on the control panel display.**
The unit is not functioning properly. Please contact Customer Service at 02 8801 7666 or 0800 862 0453 So we may better assist you, please register your product online at ninjakitchen.com.au or ninjakitchen.co.nz and have the product on hand when you call.
- **Why is my food overcooked or undercooked even though I used the probe?**
It is important to insert the probe lengthwise into the thickest part of the ingredient to get the most accurate reading. Make sure to allow food to rest for 3-5 minutes to complete cooking. For more information, refer to the Using the Smart Cooking Probe section.
- **Why does the preheat progress bar not start from the beginning?**
When the unit is warm from previously being used, it will not require the full preheating time.
- **Can I cancel or override preheating?**
Preheating is highly recommended for best results, but you can skip it by selecting the PREHEAT button after you press the START/STOP button.
- **Should I add my ingredients before or after preheating?**
For best results, let the unit preheat before adding ingredients.
- **Why is my unit emitting smoke?**
When using the Grill function, always select the recommended temperature setting. Recommended settings can be found in the Quick Start Guide and in the Inspiration Guide. Make sure the splatter guard is installed.
- **How do I pause the unit so I can check my food?**
When the lid is opened during a cooking function, the unit will automatically pause.
- **Will the probe grip melt if it touches the hot grill plate?**
No, the grip is made of a high-temperature silicone that can handle the Ninja® Foodi® Smart XL Grill high temperatures.
- **My food is burned.**
Do not add food until recommended preheat time is complete. For best results, check progress throughout cooking, and remove food when desired level of outcome has been achieved. Remove food immediately after the cook time is complete to avoid overcooking.
- **Why does the unit have a 1-9 scale for the Beef Preset?**
Perception of how well something is cooked differs. The 1-9 scale provides a wide range of options for each level of cook so you can customise to your liking.

CLEANING YOUR GRILL

The unit should be cleaned thoroughly after every use. Always let the appliance cool before cleaning.

- Unplug the unit from the wall socket before cleaning. Keep the lid open after removing your food to allow the unit to cool more quickly.
- The cooking pot, grill plate, crisper basket, splatter guard, cleaning brush, and any other included accessories are dishwasher safe, except the probe. **DO NOT place the probe in the dishwasher.**
- For the best dishwasher cleaning results, we recommend rinsing the grill plate, crisper basket, splatter guard and any other accessories with warm water before placing them in the dishwasher.
- If hand-washing, we recommend using the included cleaning brush to help wash the parts. Use the opposite end of the cleaning brush as a scraper to assist with releasing baked-on sauces or cheese. Air-dry or towel-dry all parts after hand-washing.

NOTE: DO NOT use liquid cleaning solution on or near the probe socket. We recommend using compressed air or a cotton swab to avoid damaging the socket.

- If food residue or grease are stuck on the grill plate, splatter guard, or any other removable part, soak in warm soapy water before cleaning.
- Clean the splatter guard after every use. Soaking the splatter guard overnight will help soften the baked-on grease. After soaking, use the cleaning brush to remove the grease from the stainless steel frame and front tabs.
- Deep clean the splatter guard by putting it in a pan of water and boiling it for 10 minutes. Then, rinse with room temperature water and allow to dry completely.
- To deep clean the probe, soak the stainless steel tip and silicone grip in warm, soapy water. **DO NOT** immerse the cord or jack in water or any other liquid.

The probe storage compartment holder is **handwash** only.

NOTE: NEVER use abrasive tools or cleaners. **NEVER** immerse the main unit in water or any other liquid.

ONE (1) YEAR LIMITED REPLACEMENT WARRANTY

For guarantee claims, you will need to submit a proof of purchase in the form of a valid receipt that displays date and place of purchase. This warranty does not replace but is in addition to your statutory rights.

If your product becomes defective due to faulty material or workmanship within a period of 1 year from the date of purchase, we warrant to do the following:

- For New Zealand Consumers: We will replace the defective/faulty part with a new product, free of charge, or if the unit is deemed defective/faulty we replace the unit with an equivalent or upgraded model, at our discretion.
- For Australian Consumers: Our goods come with guarantees that cannot be excluded under the Australian Consumer Law. You are entitled to a replacement or refund for a major failure and for compensation for any other reasonably foreseeable loss or damage.

Replacement items will be covered by the limited warranty for the balance of the warranty period from the date of the original purchase. Please note:

Your warranty is subject to the following conditions

- **DO NOT** operate the appliance with a damaged plug or cord, or if the unit has been dropped, damaged or dropped in water.
- To avoid the risk of electric shock, do not disassemble or attempt to repair the appliance on your own. If the supply cord is damaged, it must be replaced by a qualified electrician to avoid a hazard. Incorrect re-assembly or repair can cause a risk of electric shock or injury to persons when the appliance is used.
- The item has not been misused, abused, neglected, altered, modified or repaired by anyone.
- The item has been subjected to fair wear and tear.
- The item has not been used for trade, professional or hire purposes.
- The item has not sustained damage through foreign objects, substances or accident.

What is not covered?

- Accessories supplied with the item.
- Components that are subject to natural wear and tear caused by normal use in accordance with operating instructions.
- Unauthorised/improper maintenance/handling or overload is excluded from this warranty.

Customer costs within warranty

The customer is responsible for any inwards freight charge to return a product for warranty if requested, and outward freight charge for warranty parts and or replacement unit.

